

FULL HD Vehicle Video Recorder User Manual



2013 JUL V1.0



optional

Safety Precautions

Please Take and review some testing videos initially to make sure the images were recorded correctly.

Please note that manufacturer, its subsidiaries and affiliates, and its distributors are not liable for consequential damages arising from any malfunction of main device accessory, including memory device that results in the failure of an image to be recorded or to be recorded in a way that is machine readable.

Before using the product, please ensure that you read the safety precautions described below. Always ensure that the product is used correctly.

- Use only recommended power sources.
- Do not attempt to disassemble, alter or apply heat to the product.
- DO NOT apply multi cigarette lighter adapters-Applying such devices will cause unstable power input to damage the vehicle video recorder.
- Please always make sure all power connectors are fully secured.
- Avoid dropping or subjecting the product to severe impacts.
- To avoid the risk of injury, do not touch the interior of the product if it has been dropped or otherwise damaged.
- Stop using the product immediately if it emits smoke, a strange smell, or otherwise behaves abnormally.
- Do not use organic solvents such as alcohol, benzene, or thinner to clean the product.
- Do not let the product come into contact with water (e.g. sea water) or other liquids.
- Do not allow liquids or foreign objects to enter the VVR.
- Do not place the VVR near or in direct flame.
- Do not handle the power cord with wet hands.
- Do not use the equipment in a manner that exceeds the rated capacity of the electrical outlet or wiring accessories.
- Do not use if the power cord or plug are damaged, or not fully plugged into the outlet.
- Do not allow dirt or metal objects (such as pins or keys) to contact the terminals or plug.
- Avoid using, placing or storing the product in the humid or dusty areas.

Index

A. Feature Description	1
B. Specification	2
C. Accessories	2
D. Installation.....	3
E. Control Panel/Function Board.....	5
F. SD Card Installation.....	6
G. Function Panel.....	7
H. OSD Menu function	9
I. VACRON Viewer Player	10
J. Record Time Estimation.....	19
K. Appendix: The Indication of Bright and Dark Spot of LCD	20

A. Feature Description

- Full HD Real-time recorder (H.264 compression technology).
- 105° Wide-angle CMOS Lens.
- 2.5" TFT LCD.
- Record video with sound inside and outside the car.
- Compatible with SDHC Card up to 32GB.
- Loop recording / on start recording.
- Emergency recording, file save to separate area to prevent overwritten.
- Built-in G-Sensor, auto recording accident footage.
- Made in Taiwan with 3 year warrantee.

B. Specification

Item	Description
Sensor	CMOS
View Angle	105° Wide-angle
Resolution	Full-HD NTSC 1080P/30 fps ; PAL 1080P/25 fps
V / A	DC5V±5% / 1A
Operating tmp.	-10°C ~ +60°C
Display	2.5" TFT LCD
Storage	4GB SDHC Card or above (Recommend 『SanDisk』 Class 10 or above)
Recording	Auto recording 30 secs after power on. Footages will be preserved after power off.
Recording content	Date/Time/Image/Sound/G-Sensor data)
Storage Format	Special format, playing on LCD screen. Or specific Player bundled.
Audio Input	Built-in microphone
Time setting	Built-in permanent calendar with adjustable function through remote control or bundled Player. ※CR1220 Battery can be replaced by users.
G-Sensor	Built-in 3D G-Sensor

C. Accessories

- Standard
Adapter / Software CD / Bracket / Quick user manual
- Optional
4G / 8G / 16G / 32G Class10 or above SDHC Card

D. Installation.

1. To install the device on the windshield by “Stick-Holder” Type

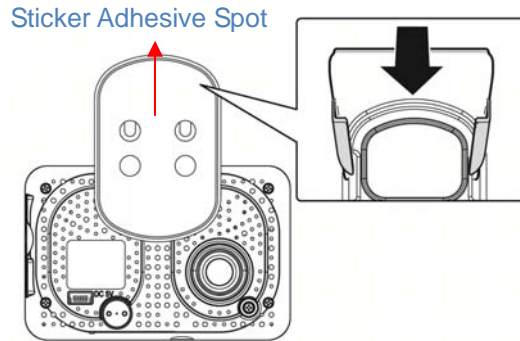

2. The best position to install the device on the windshield

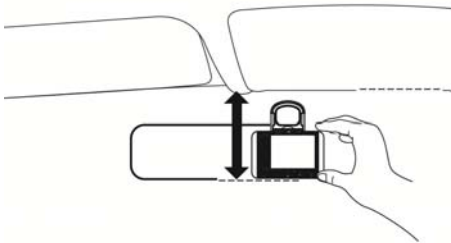

3. To adjust the recording angle properly

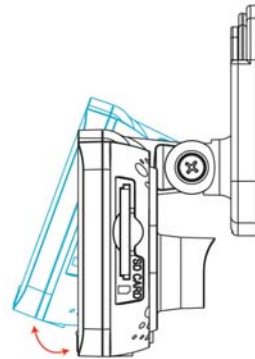

4. Plug in DC5V Power Supply

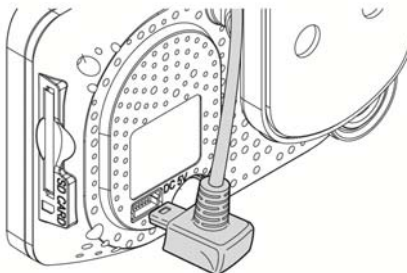

5. Plug in the Cigarette Charger

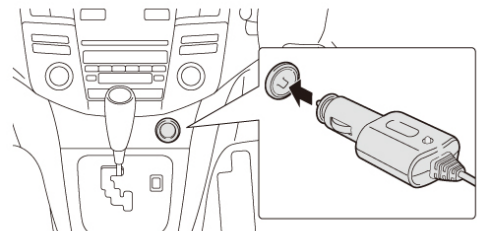

6. VVR installation

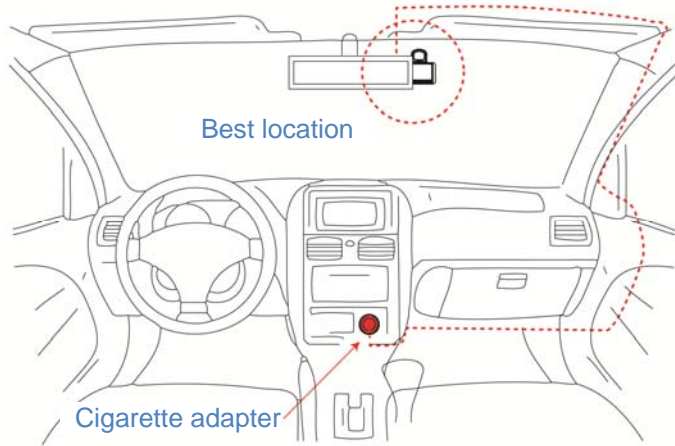

Caution

- (1). This device should be installed in the area where the windshield will be able to be cleaned.
- (2). Formatting SD card on the device before beginning to use.
- (3). Set time zone and timing on OSD.
- (4). NTSC or PAL setting through OSD.

E. Control Panel/Function Board

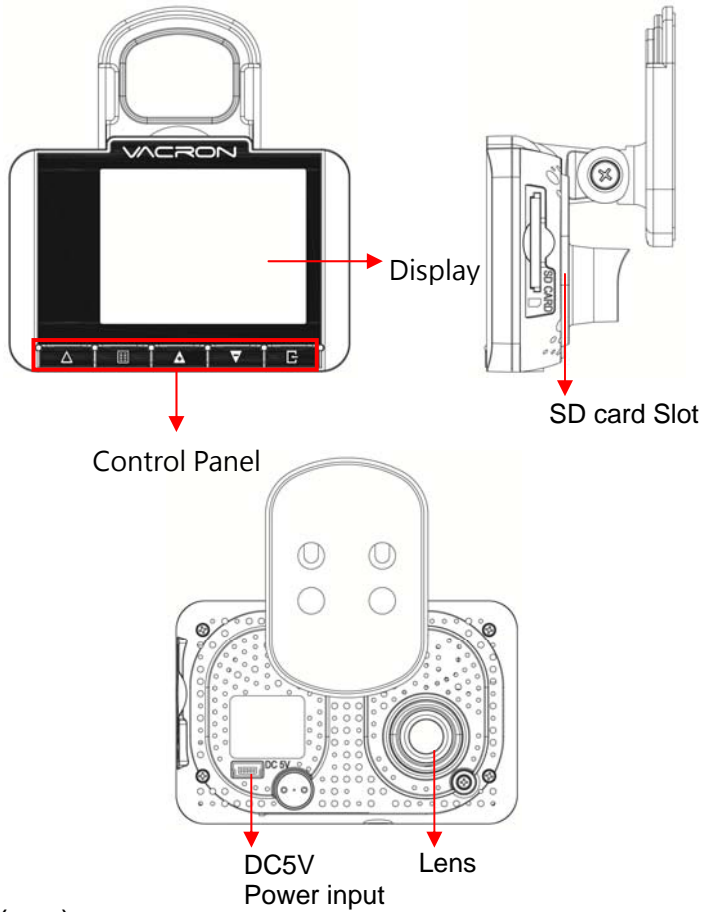

Dimension (mm)

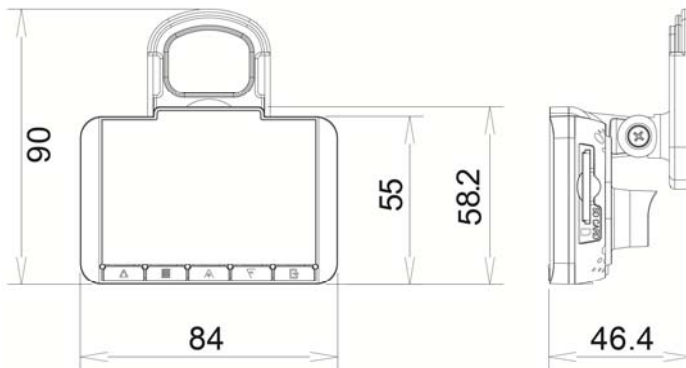

F. SD Card Installation

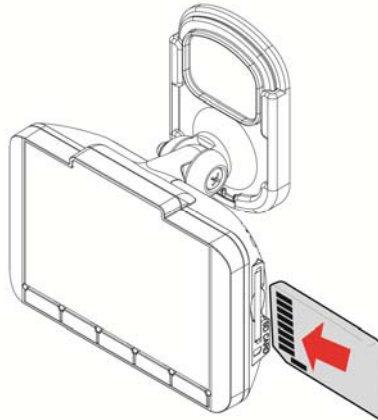

- (1). Format memory card; please refer to the other chapter “Formatting memory card” for more detail.

Remark: Memory Card is optional



Caution

- (1). Recommend Memory Card “SanDisk” Class 10 or above. (Minimum of 4GB)
- (2). If the memory card is not formatted by our exclusive player, the device will automatically erase all the data inside of the memory card after inserting it, start recording at default setting.
- (3). Please don't convert Micro SD to SD card to begin recording, to avoid the damage during recording.
- (4). Since memory cards have the writing endurance situation, we recommend to inspect the memory card and use pc for playback regularly, to ensure that the memory card can read and write

G. Function Panel

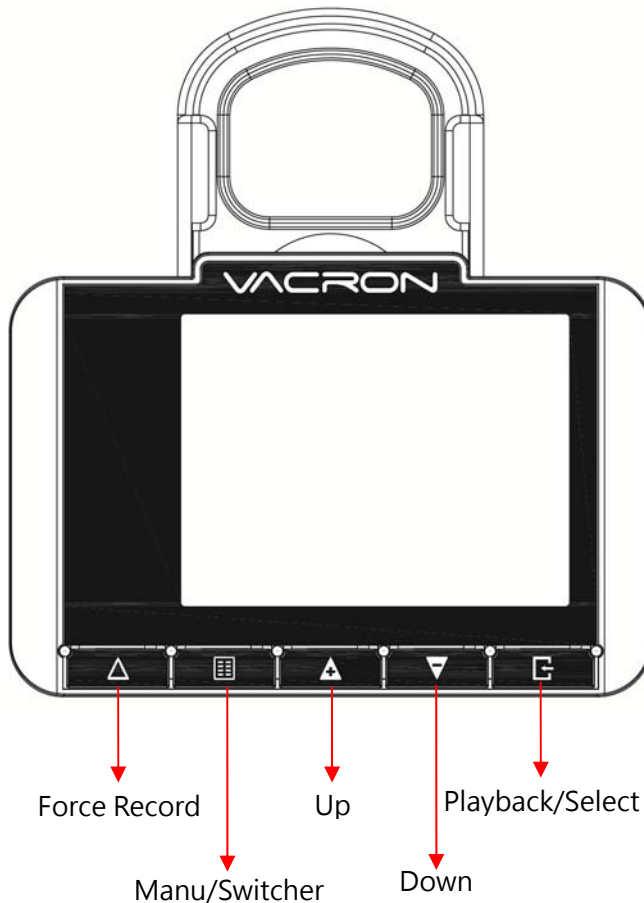

- To press force record any time under operation will trigger force recording.
- LED indicators
 - Red: Under normal operation-recording
 - Fast Blinking Red: Force recording
 - Green : Low light indicator

Recording / Stop Recording

1. **Power On/Recording**

When car power on, the device start up automatically. Please wait for 30 Sec. to start recording.

2. **Power Off/Stop recording**

When the car power off, the device will stop to record video and sound. You can take off the memory card and insert to computer to view the video.





3. **Indication**

Red light Blinking when recording. (Emergency recording blinking fast)

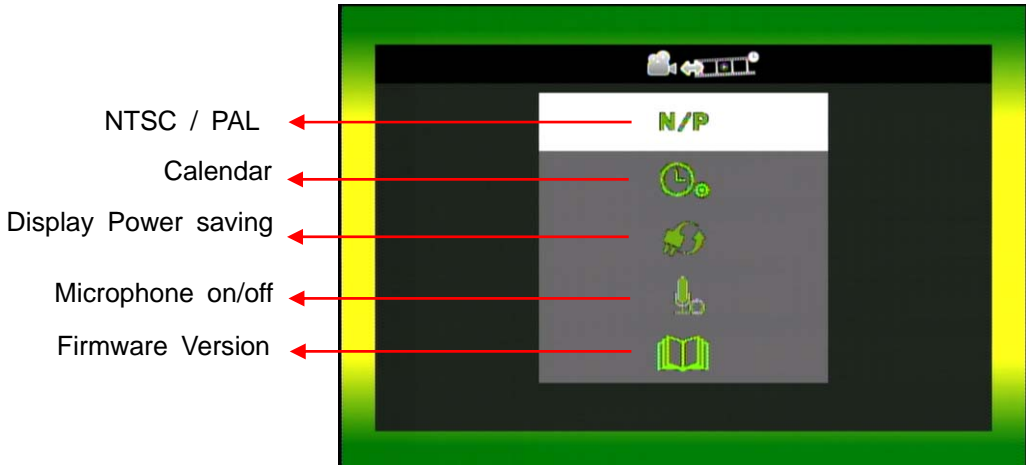
H. OSD Menu function

In Live view screen press  will popup OSD operation menu as follows:









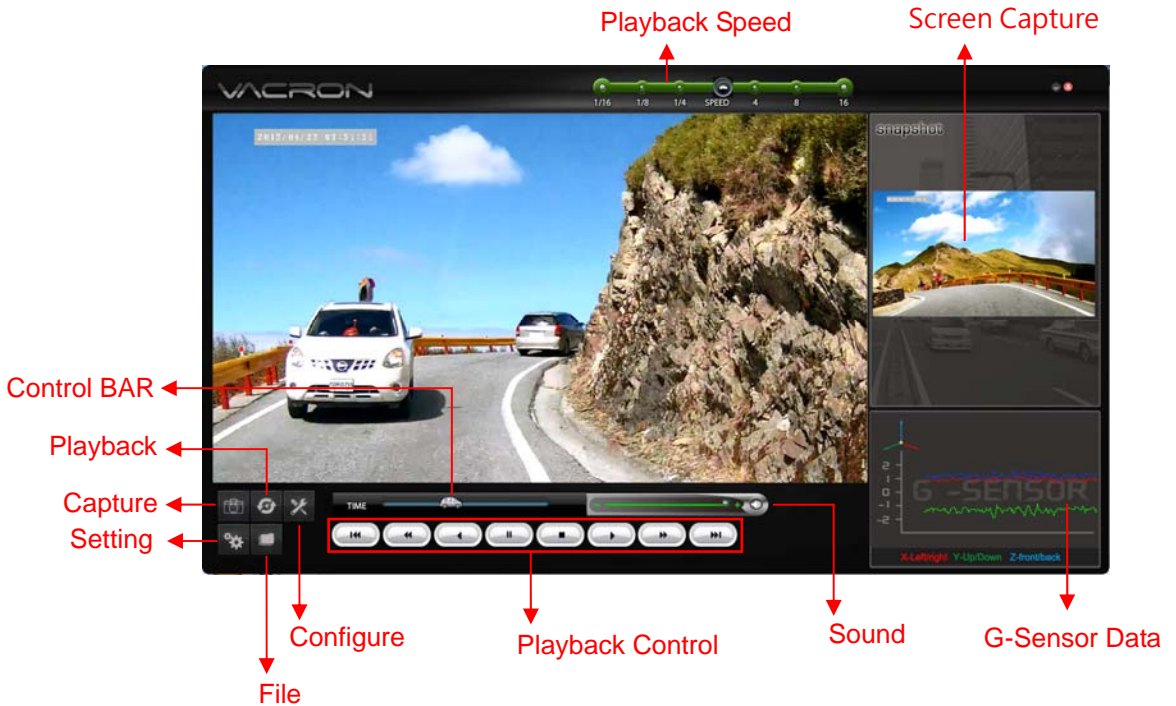

1. Select  to export NTSC or PAL signals
2. Select  to set built-in clock.
3. Select  to set power saving on display
4. Select  to set microphone on/off
5. Select  to view the current firmware version

I. VACRON Viewer Player

★DirectX 9.0 or above is required.



1. Operation icon introduction

	Back to previous file
	Previous image
	Rewind
	Pause
	Stop
	Play
	Next image
	Next footage

2.  Capture: Capture the current screen image

You can capture the image when play the footage, click  button the capture the image, The following windows will shows, the image you captured is showing on the right side. File saving cdirectory are in /Snapshot folder, and the file type is *.bmp.

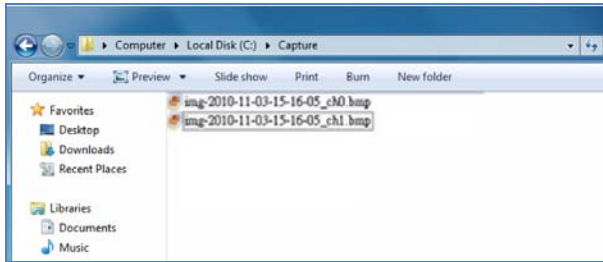

(Select File)



(SNAPSHOT show)

3.  Play back: Open file

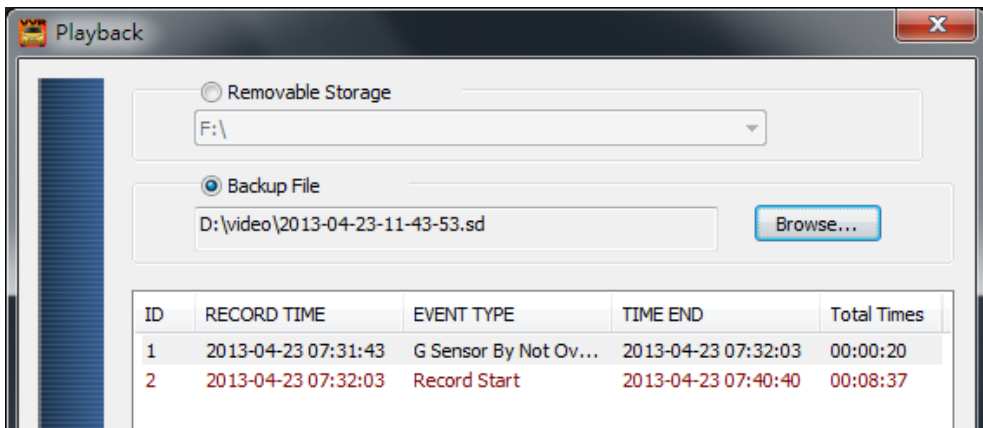

4.  Format: Format memory card/Langue setting

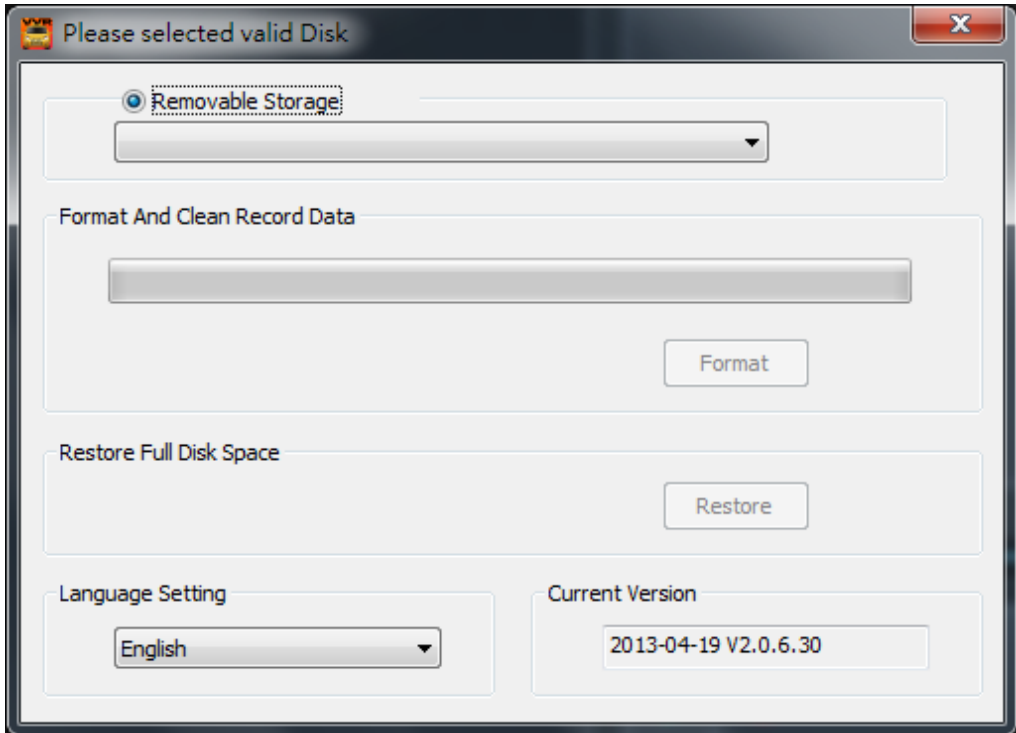

Caution

- (1). 「Format / Restore」 will clean all the data saved on SD card, Please back up the data before 「Format / Restore」 .
- (2). Before 「Format / Restore」 SD memory card, please ensure to unlock it first.
- (3). If the card is unlocked but still cannot be formatted, this might be caused by Window Vista / 7 security restrictions. Please run the program as Administrator to prevent from this problem.

a. 「Format」 SD card

While applying a brand new SD card, formatting is required.

b. 「Restore」 SD card

When you have backup the recorded files into PC and want to use the SDHC card for other purposes, you have to restore it first so it can be used correctly.

c. Language setting

Select the designated the display language.

* Note: New language setting will start after rebooting.

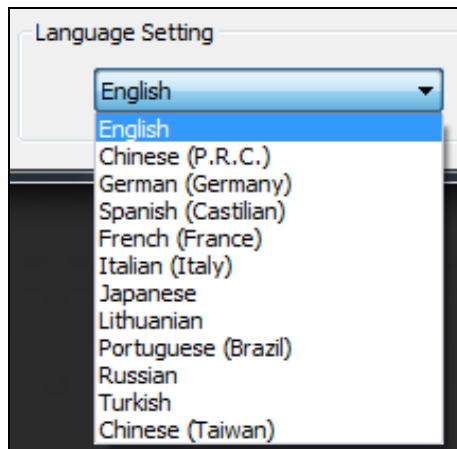

d. Current Version

Version Support VACRON web site <http://vvr.vacron.com>

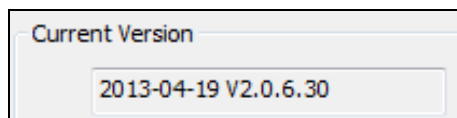

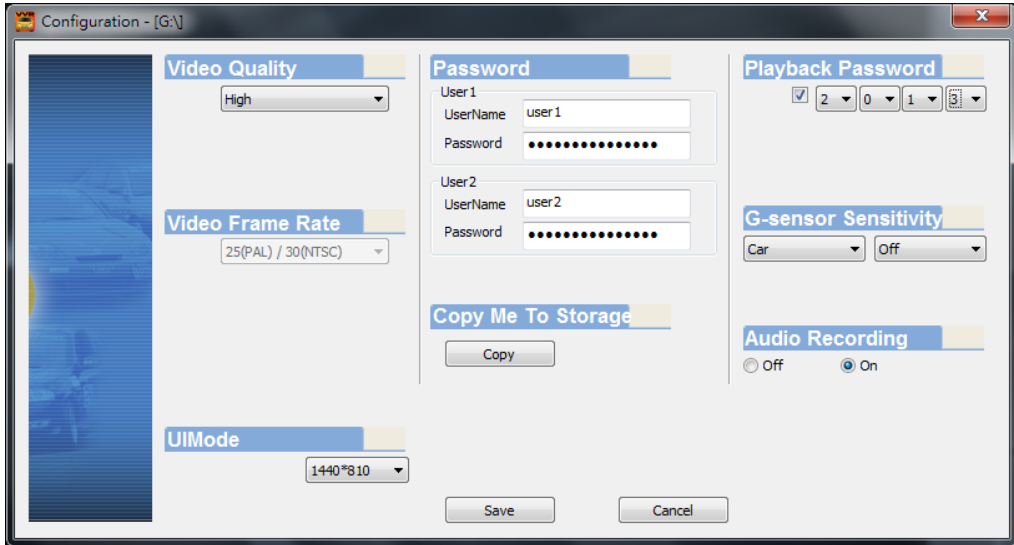

5.  Configuration: configure default setting

Put the SD Card into Card reader and plug-in the card reader into the USB slot of your PC to format the SD card before the first time to record. Then also need to configure video type and display way, When finish the setting, insert the SD card the vehicle video recorder to start recording.

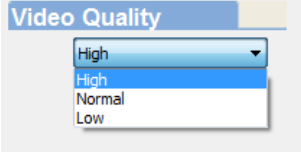
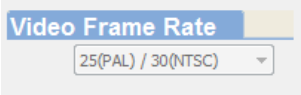
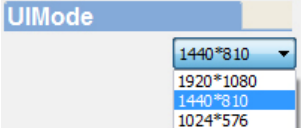

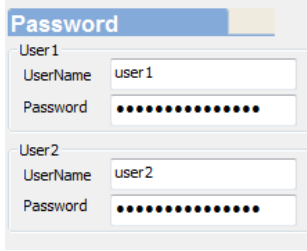
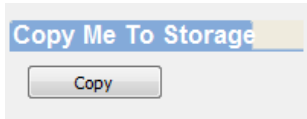
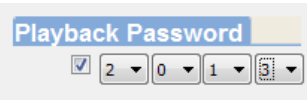
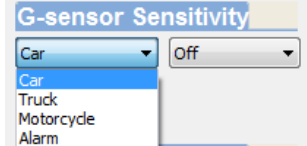
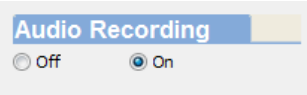
1	Image quality		The default quality is high / Normal / Low
2	fps setting		25(PAL) / 30(NTSC)
3	UI Mode		The resolution can be adjusted.

4	Password		<p>This function can encrypt the SD card to prevent illegal retrieving from others, the password is under 15 character, for example:123456789123456</p> <p>You will need input password when you playback/configuration/format SD card if you set a password.</p> <p>★Note: Upper/lower character is different; remember the password is very important.</p>
5	Copy the player to SD card		Copy the player to SD card.
6	Password in LCD playing		You can set the password, when playback on the device LCD, you need to unlock the password.
7	G-sensor sensitivity		Vehicle type and G-Sensor's sensitivity can be adjusted.
8	Audio recording		Audio recording on/off

6.  File backup: click to choose file save directory.

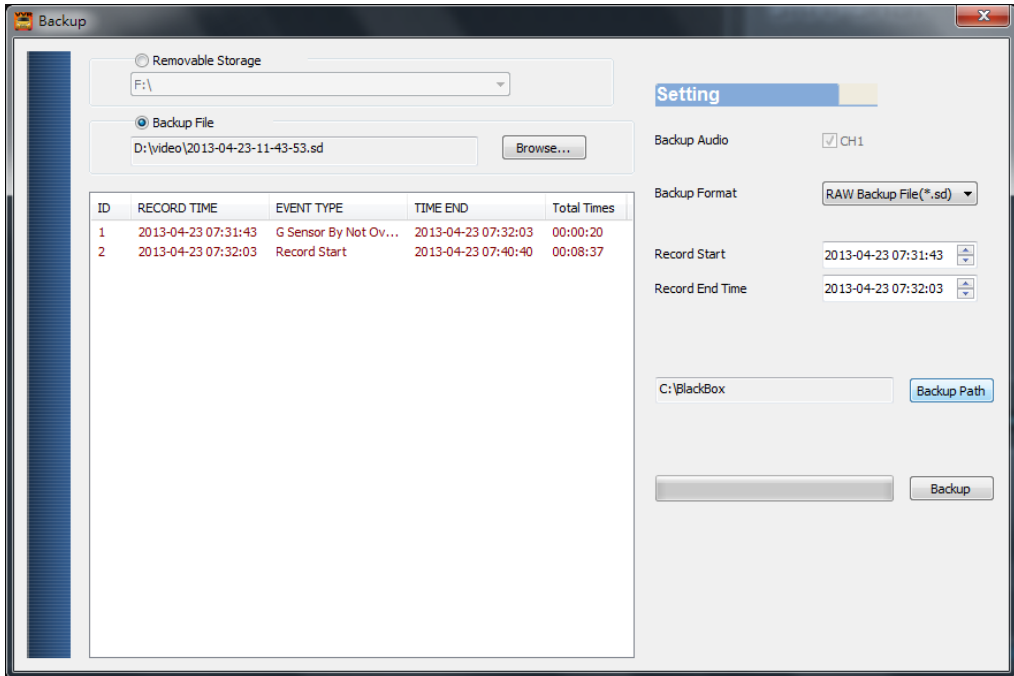

Step1. Choose the source of the memory card.

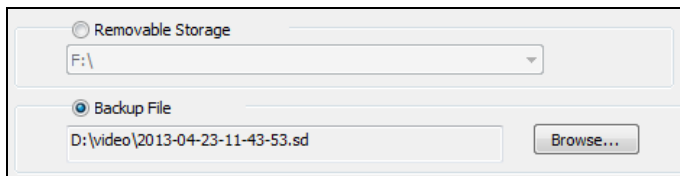

Step2. Choose the designated footage to backup.

ID	RECORD TIME	EVENT TYPE	TIME END	Total Times
1	2013-04-23 07:31:43	G Sensor By Not Ov...	2013-04-23 07:32:03	00:00:20
2	2013-04-23 07:32:03	Record Start	2013-04-23 07:40:40	00:08:37

Step3. Choose the target file format and start/end record time.

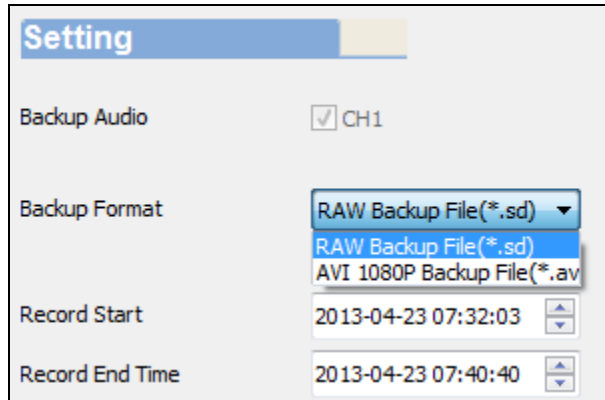

File format

(1) Our original file format

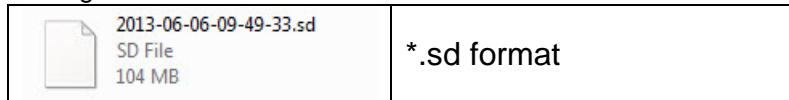

(2)AVI File Backup(*.avi)

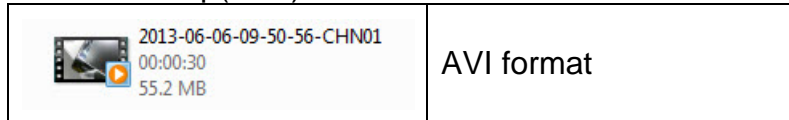

★Note: G-sensor data can only be displayed on manufacturer's player.

Step 4. Set the backup folder: default is C:\BlackBox

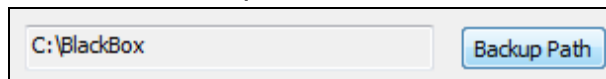

Step 5. Start to backup

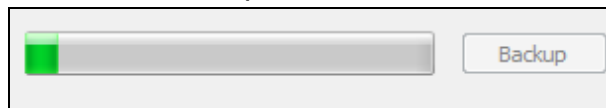

7. Play BAR: You can use Mouse to drag the car icon to move footage location



8. Play speed: 4X \ 8X \ 16X and quick playback, 1/4X \ 1/8X \ 1/16X and slow playback.



9. Volume control: Click + \ - to adjust volume.

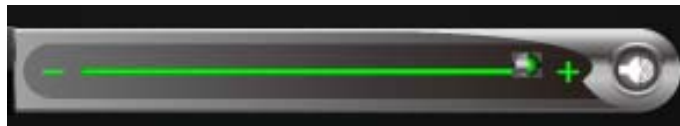

10. G-SENSOR

G-Sensor will detect the impact form the car, and record 1-3 minutes footage automatically. This footage will save to separate area to avoid file from being overwritten.



- (1) **X**: Detect vehicle horizontal change.
- (2) **Y**: Detect vehicle vertical change.
- (3) **Z**: Detect vehicle front/back change.

J. Record Time Estimation

The chart below is for reference only. The length of time recorded can be varied due to variation in image size may be different.

Capacity	8G	16G	32G
Video Quality			
High	120 Min	240 Min	480 Min

K. Appendix: The Indication of Bright and Dark Spot of LCD

Q: What is Bright/Dark Spot?

- A :
- Bright Spot: At dark background, we found the abnormal bright spots, we called those spot are “Bright Spot”
 - Dark Spot: At multiple color background (excluded dark background), we found the abnormal dark spot, we called those spot are “Dark Spot”

Q: The indication of Bright and Dark Spot

- (a) There is no bright spot allowed in Area A, only single dark spot or none is allowed.
- (b) The maximum amount of bright spots and dark spots allowed in Area B are two of each.
- (c) The max total amount of bright and dark spots in Area A and B are three or under

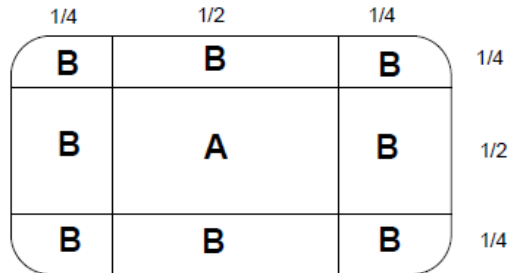

The Diagram of Area A and B



Caution

- (1). There is 30 days exchanges refer to the indication of bright and dark.
- (2). Please keep the receipt and contact your local dealer for exchanging merchandise.
- (3). The maximum valid date is 30 days.



For More Information
Please check VACRON Website
<http://www.vacron.com>

Made in Taiwan
